



PALMIYE

HOME COMFORT

BRILLIANT

The shining structure of pure brilliance

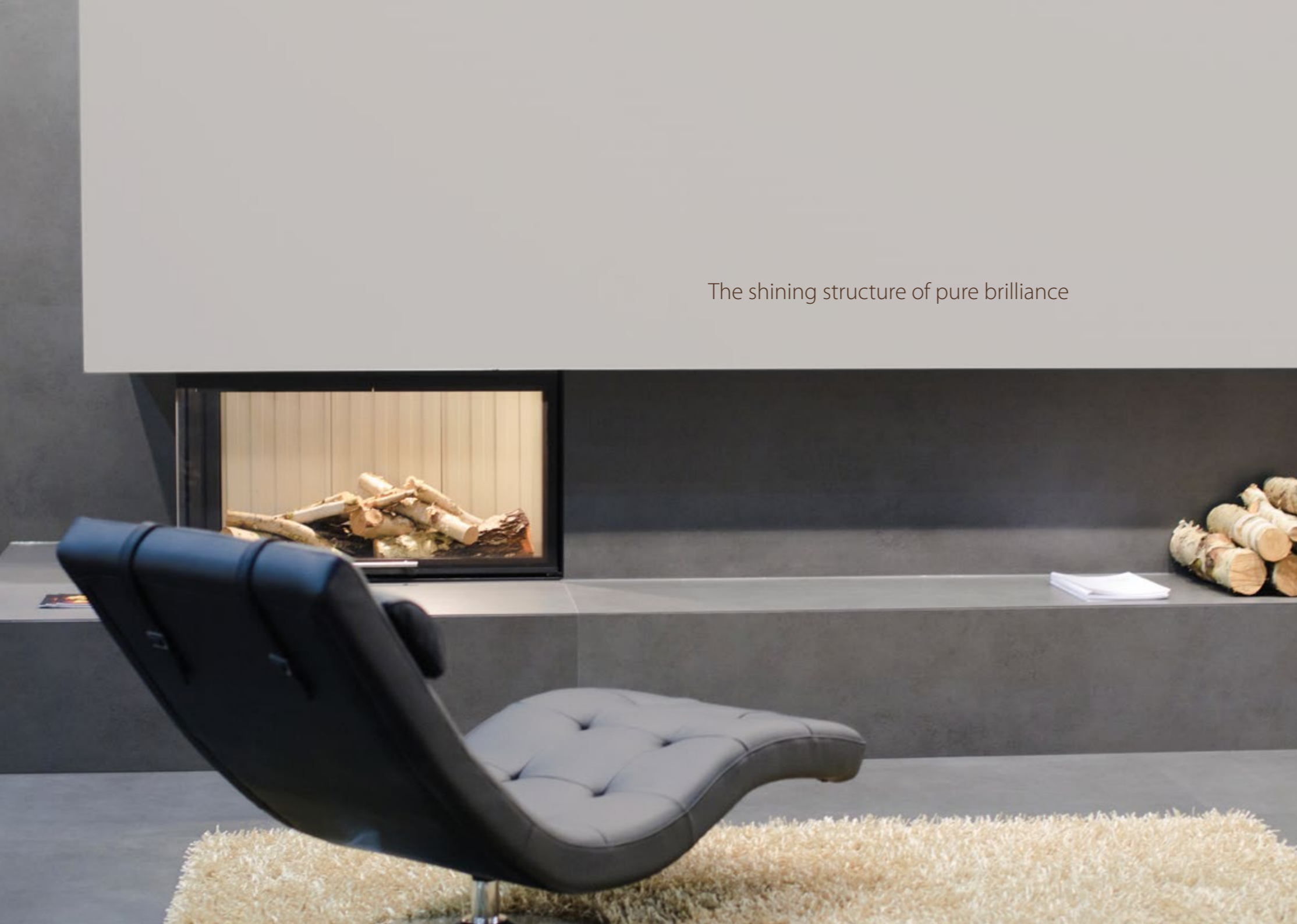

Simple and clean-cut in its design, Brilliant welcomes you and your friends with style and charisma. Experience the changing seasons from within the comfort of your own Brilliant space.









DETAILS 
OPTIONS

MOTOR & AUTOMATION



Internationally renowned Somfy motors from France are used to operate all of our products. Guaranteed for 5 years and using RTS technology, the motors can be operated at the simple touch of a button.



Solar Sensor



Wind Sensor

PALMIYE APPS

We are proud to present our own MyPalmiye App which has been designed specifically for Palmiye products and is available at Apple's App store.

Now you can take full control of your Palmiye experience and choose from several options, directly from your iPhone or iPad.

These include:

- Activating the infra-red heaters.
- Adjusting the FourSeasons cover.
- Dimming the lights.
- Playing your favourite music.



FABRIC



Palmiye presents a broad range of fabrics with a wide selection of colours, patterns and elegant designs imported from the USA, France, Spain and Italy, and all with 5 years guaranty against fading and mould.

FS Flexy



FS Flexy fabric, which is used in all Four Seasons products, is a light weight PVC-based material. Consisting of 3 layers, it is highly resistant in many ways including being fully flame retardant and water resistant as well as filtering UV light. Exclusively produced for Palmiye, it is easy to clean and is available in white, ivory and grey.

Izo Pro

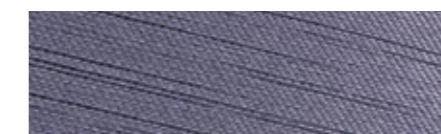

Patented by Palmiye, Izo Pro is a unique example of what Nano technology can offer. Its insulating functions mean that it ensures a room is kept cool in the summer whilst making it easy to heat during the winter months.

As well as being considered soundproof it plays a big part in energy saving and Green technologies.

Ferrari Soltis



Specially designed for Palmiye in such a way that it is see-through despite still blocking the sun and 95% of UV rays, this fabric has a natural citronella scent and acts as a subtle insect repellent that gently perfumes the area.

5 YEAR WARRANTY

FERRARI

SATTLER
the lightEX company

sunbrella™

TECHNICAL DETAILS

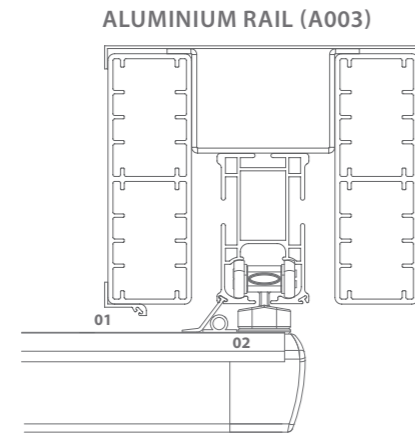

ALUMINIUM RAIL (A003)

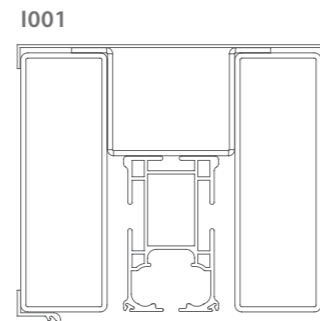

I001

- Inox
- Aluminium

01 DOUBLE ANTI-AIR SYSTEM
This system prevents the wind entering between the ceiling cover, rails and gutter, and creates an airtight space into which the wind cannot enter.

02 WATERBLOCK
This prevents rainwater entering the enclosed area, and leads it directly to the front gutter for perfect water drainage.



Distinguished by their design, durability and state-of-the-art detailing, all of our products are certified by TUV and ISO.

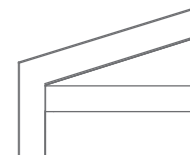

HORIZONTAL BEAMS

The front and side beam are on the same horizontal level, giving a continuous line throughout the product, ensuring a smooth relaxing overall look, which is a delight to the eye.

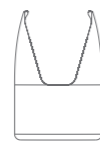

SPOT LIGHTS

Depending on whether you want strong practical lighting, or an atmospheric dimmed ambience, choose from 1 or 3 Watt LED lighting options. Investing in LED technologies is part of Palmiye's contribution to a green environment.

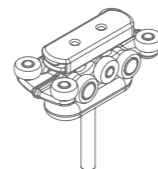

10-WHEEL CAR

Our specially designed 10 wheel car drive, with its one-part stainless steel body, ensures silent, fast and balanced operation of your product.



WALL JOINER FINISH

Typical of Palmiye, every last detail is of utmost importance. With these attractive caps, the joint between the wall and the product is covered to ensure the perfect fit and brings together the final look.

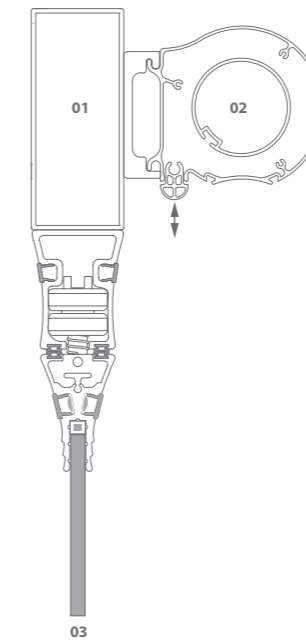

01 SEPERATE FRONT BEAM
The separated front beam carries all the weight of the roof without putting any pressure on the gutter. Additionally it is also responsible for carrying awnings and glass systems.

02 VERTICAL BLIND
Horizontal sun rays can be reduced with a vertical blind. It is a full cassette awning and the Ferrari Soltis fabric, provides shade without interrupting the view.

03 GLASS SYSTEMS
Different glass systems can be installed directly onto the front beam.



Palmiye with an international network and organizational structure, is represented in many countries worldwide.

The values of each different culture and their unique architectural concepts, inspire and are reflected in Palmiye's products.

As an open-minded innovator, Palmiye operates sensitively, tailoring distinctive and incomparable products, where the thoughts and feelings of world famous architects and designers are brought to life.

Palmiye, through its team of professional designers, architects and engineers, shares possible solutions with customers and ensures that they experience the true meaning of the word "unique".

Taking their place within the ever growing 'smartphone' culture, the MyPalmiye App ensures that control of each product is now with the greatest of ease.

By channelling their extensive knowledge and experience with shade systems into retractable products, which can be used all year round, their professionalism has entered a new dimension.





PALMIYE

www.palmiye.eu