



PALMIYE  
CATERING  
SILVER



"...and they danced  
by the silver light of the moon."



With its clean lines and modern design, Silver is an unobtrusive yet stylish way to get the best out of your outdoor area, distinguishing itself from other establishments in the neighbourhood









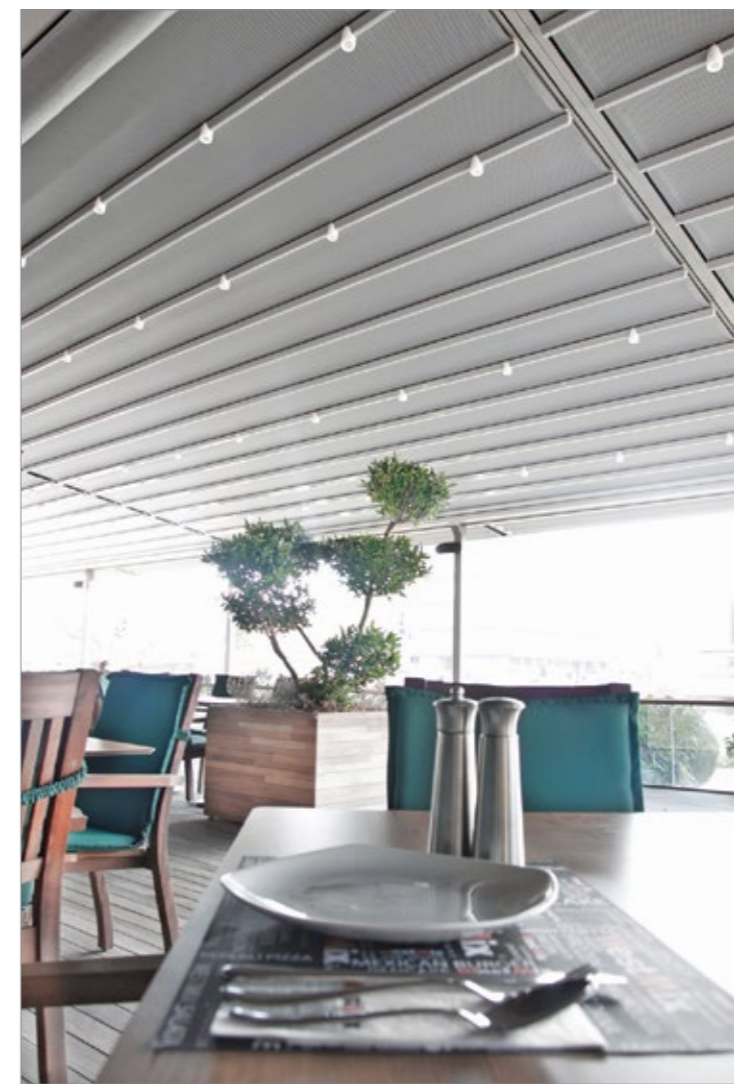





R E L A X













DETAILS   
OPTIONS

## MOTOR & AUTOMATION



Wind Sensor



Solar Sensor



**somfy.**

Internationally renowned Somfy motors from France are used to operate all of our products. Guaranteed for 5 years and using RTS technology, the motors can be operated at the simple touch of a button.

## PALMIYE APPS

We are proud to present our own MyPalmiye App which has been designed specifically for Palmiye products and is available at Apple's App store.

Now you can take full control of your Palmiye experience and choose from several options, directly from your iPhone or iPad.

These include:

- Activating the infra-red heaters.
- Adjusting the FourSeasons cover.
- Dimming the lights.
- Playing your favourite music.



# FABRIC



Palmiye presents a broad range of fabrics with a wide selection of colours, patterns and elegant designs imported from the USA, France, Spain and Italy, and all with 5 years guaranty against fading and mould.

5 YEAR WARRANTY



## FS Flexy



FS Flexy fabric, which is used in all Four Seasons products, is a light weight PVC-based material. Consisting of 3 layers, it is highly resistant in many ways including being fully flame retardant and water resistant as well as filtering UV light. Exclusively produced for Palmiye, it is easy to clean and is available in white, ivory and grey.

## Izo Pro

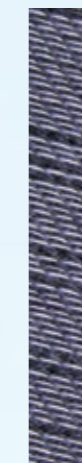

Patented by Palmiye, Izo Pro is a unique example of what Nano technology can offer. Its insulating functions mean that it ensures a room is kept cool in the summer whilst making it easy to heat during the winter months. As well as being considered soundproof it plays a big part in energy saving and Green technologies.

## Ferrari Soltis

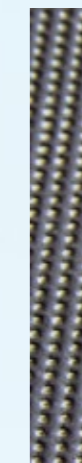

Specially designed for Palmiye in such a way that it is see-through despite still blocking the sun and 95% of UV rays, this fabric has a natural citronella scent and acts as a subtle insect repellent that gently perfumes the area.

# TECHNICAL DETAILS

## ALUMINIUM RAIL (A001)

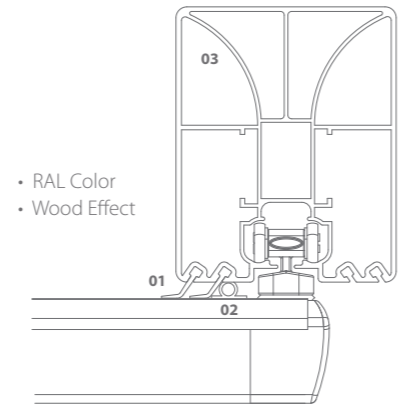

- RAL Color
- Wood Effect

### 01 DOUBLE ANTI-AIR SYSTEM

This system prevents the wind entering between the ceiling cover, rails and gutter, and creates an airtight space into which the wind cannot enter.

### 02 WATERBLOCK

This prevents rainwater entering the enclosed area, and leads it directly to the front gutter for perfect water drainage.

### 03 GEOMETRIC CROSS SECTION

With its geometric design, the specially engineered inner section gives maximum strength and wind resistance to the aluminium rail profile.

## A002

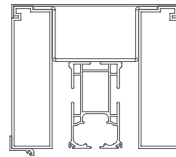

## A003

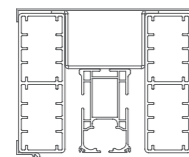

## W001

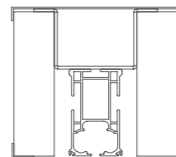

- Massif Wood

## W002

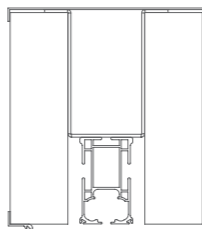

## G001

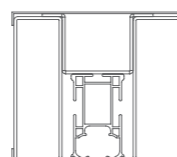

## G002

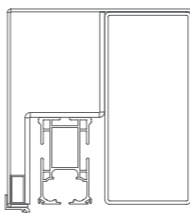

Distinguished by their design, durability and state-of-the-art detailing, all of our products are certified by TUV and ISO.

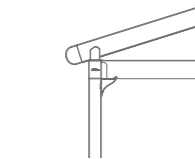

### HORIZONTAL BEAMS

The front and side beam are on the same horizontal level, giving a continuous line throughout the product, ensuring a smooth relaxing overall look, which is a delight to the eye.



### SPOT LIGHTS

Depending on whether you want strong practical lighting, or an atmospheric dimmed ambience, choose from 1 or 3 Watt LED lighting options. Investing in LED technologies is part of Palmiye's contribution to a green environment.

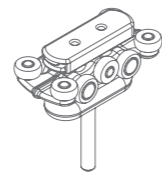

### 10-WHEEL CAR

Our specially designed 10 wheel car drive, with its one-part stainless steel body, ensures silent, fast and balanced operation of your product.

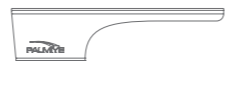

### WALL JOINER FINISH

Typical of Palmiye, every last detail is of utmost importance. With these attractive caps, the joint between the wall and the product is covered to ensure the perfect fit and brings together the final look.



### IDS

Specifically designed to add a nice aesthetic touch as well as being highly functional, this Integrated Drainage System (IDS) ensures that all water is smoothly drained inside the front pillar.

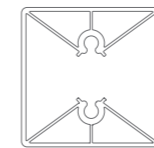

### FRONT PILLAR

Inside our cleverly engineered front pillar, all the installation details are hidden, including all screw points, ensuring that no extra connection part is needed.

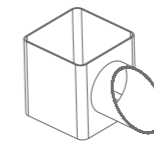

### FRONT PILLAR BASE

This stainless steel base hides all the floor installations inside, drains the water to the outside and gives an exclusive finish to your product.

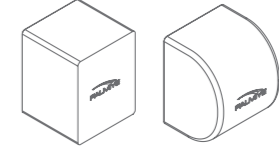

### PROFILE ENDING CAPS

Give a personal touch to your product by choosing from a rounded or straight ended cap.

### 01 RAIN GUTTER

The gutter with its height adjustment feature, provides the anti-air system, in different positions to ensure a perfect fit, according to the inclination of your product.

### 02 SEPERATE FRONT BEAM

The separated front beam carries all the weight of the roof without putting any pressure on the gutter. Additionally it is also responsible for carrying awnings and glass systems.

### 03 VERTICAL BLIND

Horizontal sun rays can be reduced with a vertical blind. It is a full cassette awning and the Ferrari Soltis fabric, provides shade without interrupting the view.

### 04 GLASS SYSTEMS

Different glass systems can be installed directly onto the front beam.

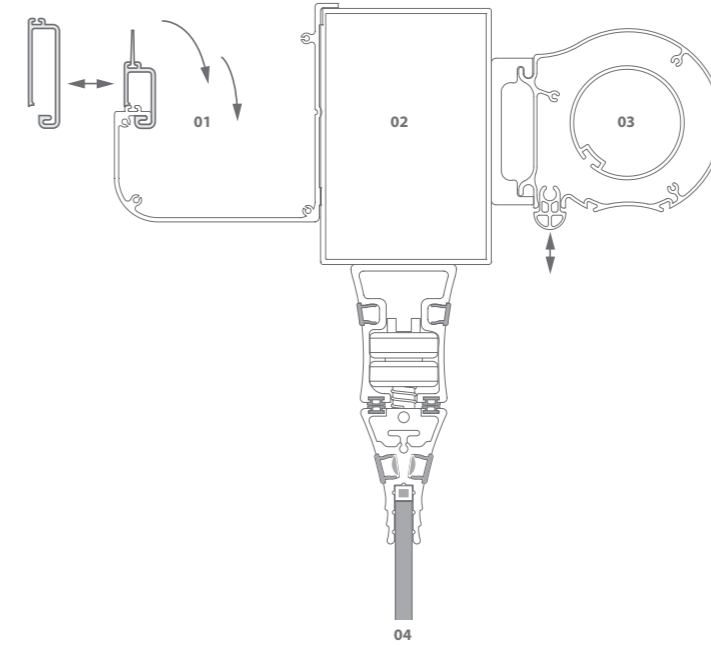

04

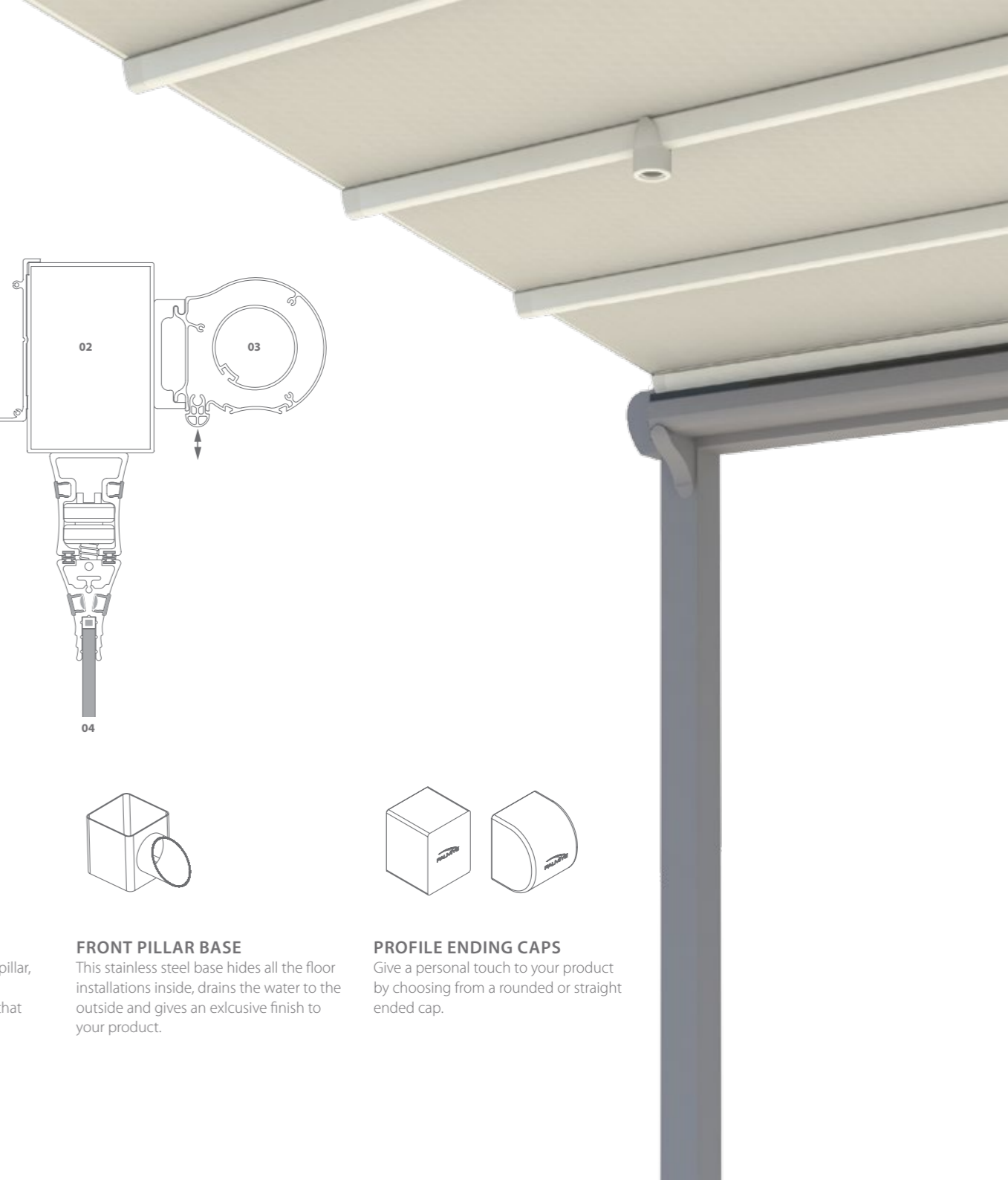

Palmiye with an international network and organizational structure, is represented in many countries worldwide.

The values of each different culture and their unique architectural concepts, inspire and are reflected in Palmiye's products.

As an open-minded innovator, Palmiye operates sensitively, tailoring distinctive and incomparable products, where the thoughts and feelings of world famous architects and designers are brought to life.

Palmiye, through its team of professional designers, architects and engineers, shares possible solutions with customers and ensures that they experience the true meaning of the word "unique".

Taking their place within the ever growing 'smartphone' culture, the MyPalmiye App ensures that control of each product is now with the greatest of ease.

By channelling their extensive knowledge and experience with shade systems into retractable products, which can be used all year round, their professionalism has entered a new dimension.





  
**PALMIYE**

[www.palmiye.eu](http://www.palmiye.eu)